

MECHANICAL WHEEL TYPE MOBILE CABINET

機械轉盤式直推櫃



Mechanical Type
機動式



Anchor Shaped
Handle Lock
錨型把手鎖



Wheel Handle
轉盤



Index Holder
目錄座



Aisle Safety Lock
通道安全鎖

產品規格 SIZE (mm) MECHANICAL TYPE 機動式

| NO. OF BAY 倉數 | WIDTH 寬度 | SINGLE FIX 單面固定櫃 (包括四件層板) | SINGLE MOVABLE 單面活動櫃 (包括四件層板) | DOUBLE MOVABLE 雙面活動櫃 (包括八件層板) | |
|------------------|-------------|---------------------------------|-------------------------------------|-------------------------------------|------------|
| | | 450DX2150H | 450DX2150H | 650DX2150H | 850DX2150H |
| 1 | 1080 | SF-M450-1 | SM-M450-1 | DM-M650-1 | DM-M850-1 |
| 2 | 1980 | SF-M450-2 | SM-M450-2 | DM-M650-2 | DM-M850-2 |
| 3 | 2880 | SF-M450-3 | SM-M450-3 | DM-M650-3 | DM-M850-3 |
| 4 | 3780 | SF-M450-4 | SM-M450-4 | DM-M650-4 | DM-M850-4 |
| 5 | 4680 | SF-M450-5 | SM-M450-5 | DM-M650-5 | DM-M850-5 |

Accessories 配套



Central Bar
中橫板

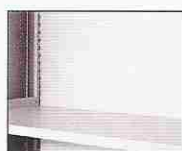

Full Length
Central Panel
中檔板



Reinforced Shelf
層板



Pull-out Frame
文件架



Divider
分格板

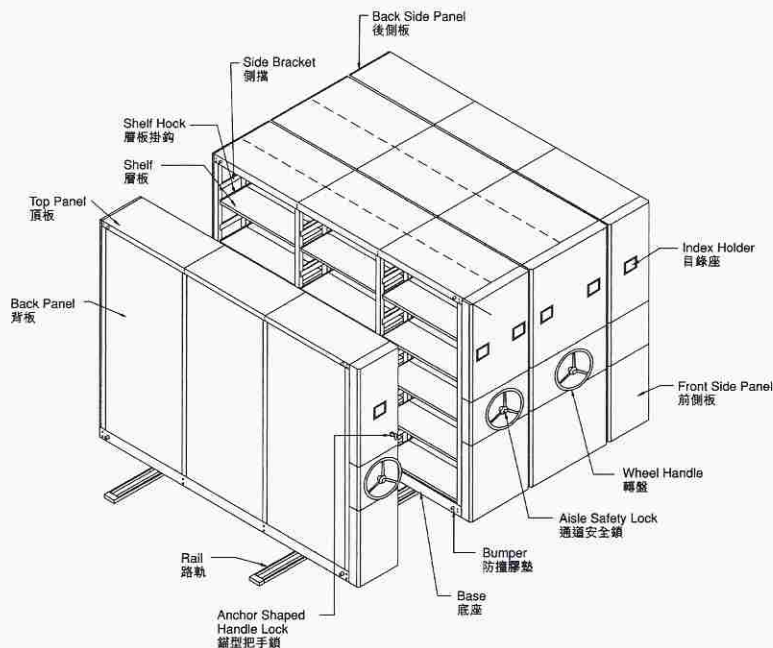

Dimension WxDxH (mm)

MANUAL TYPE MOBILE CABINET

手推式直推櫃

Manual Type 手推式

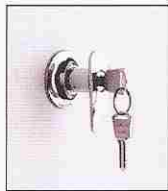

Anchor Shaped
Handle Lock
錨型把手鎖



Handle
拉手



Index Holder
目錄座



Aisle Safety Lock
通道安全鎖

產品規格 SIZE (mm) MANUAL TYPE 手推式

| NO. OF BAY 倉數 | WIDTH 寬度 | SINGLE FIX 單面固定櫃 (包括四件層板) | SINGLE MOVABLE 單面活動櫃 (包括四件層板) | DOUBLE MOVABLE 雙面活動櫃 (包括八件層板) | |
|------------------|-------------|---------------------------------|-------------------------------------|-------------------------------------|------------|
| | | 450DX2150H | 450DX2150H | 650DX2150H | 850DX2150H |
| 1 | 1040 | SF-P450-1 | SM-P450-1 | DM-P650-1 | DM-P850-1 |
| 2 | 1940 | SF-P450-2 | SM-P450-2 | DM-P650-2 | DM-P850-2 |

Accessories 配套



Central Bar
中橫板



Full Length
Central Panel
中檔板

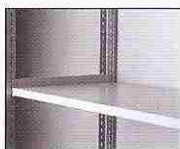

Reinforced Shelf
層板



Pull-out Frame
文件架

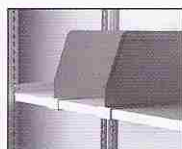

Divider
分格板

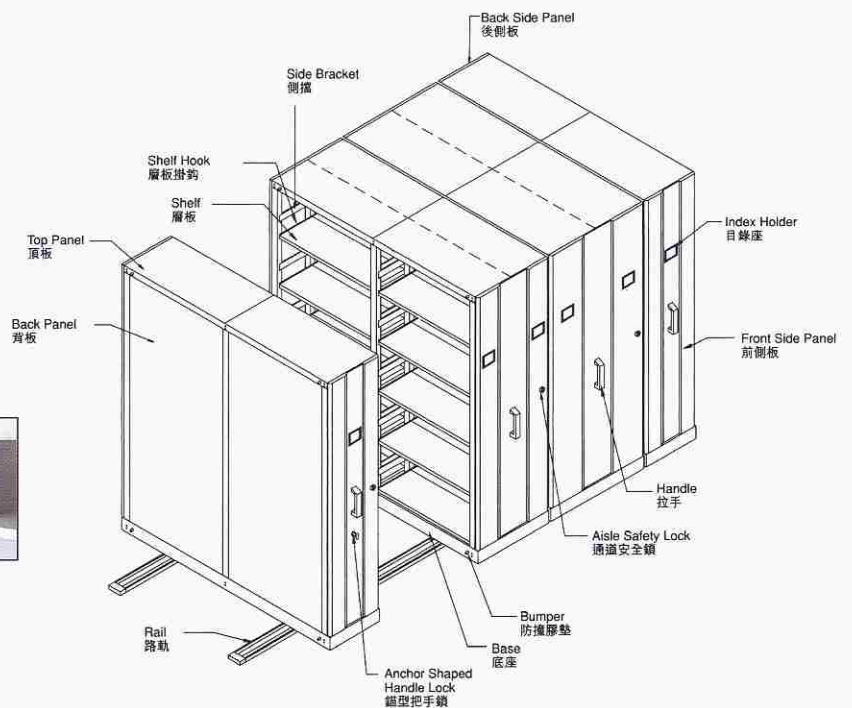

Dimension WxDxH (mm)

STEEL TABLE

鋼檯系列

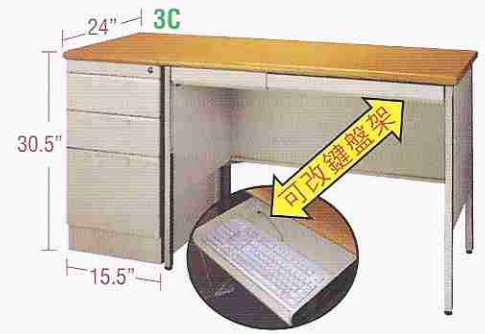

| MODEL 型號 | CENTRAL DRAWER DESK 木面中橫斗鋼檯 | SINGLE DRAWER DESK 木面單桶鋼檯 | DOUBLE DRAWER DESK 木面雙桶鋼檯 | L-SHAPED DESK 木面曲尺鋼檯 |
|-------------|--------------------------------|------------------------------|------------------------------|--|
| K600 | W36 " x D24 " x H30.5 " | W36 " x D24 " x H30.5 " | W48 " x D24 " x H30.5 " | W48 " x D24 " x H30.5 " (曲尺: W34 " x D14 ") |
| | W42 " x D24 " x H30.5 " | W42 " x D24 " x H30.5 " | W48 " x D27 " x H30.5 " | W48 " x D27 " x H30.5 " (曲尺: W34 " x D14 ") |
| | W48 " x D24 " x H30.5 " | W48 " x D24 " x H30.5 " | W54 " x D27 " x H30.5 " | W54 " x D27 " x H30.5 " (曲尺: W34 " x D16 ") |
| | W48 " x D27 " x H30.5 " | W48 " x D27 " x H30.5 " | W54 " x D30 " x H30.5 " | W54 " x D30 " x H30.5 " (曲尺: W34 " x D16 ") |
| | W54 " x D27 " x H30.5 " | W54 " x D27 " x H30.5 " | W60 " x D27 " x H30.5 " | W60 " x D27 " x H30.5 " (曲尺: W34 " x D16 ") |
| | W54 " x D30 " x H30.5 " | W54 " x D30 " x H30.5 " | W60 " x D30 " x H30.5 " | W60 " x D30 " x H30.5 " (曲尺: W34 " x D16 ") |



K614

單櫃桶鋼檯 (SINGLE)

A W36" x D20" x H30.5"

B W42" x D24" x H30.5"



HD629

木面單櫃桶鋼檯 (SINGLE)

A W36" x D24" x H30.5"

B W42" x D24" x H30.5"



雙櫃桶鋼檯 (DOUBLE)

C W48" x D24" x H30.5"

D W54" x D30" x H30.5"

E W60" x D30" x H30.5"



木面雙櫃桶鋼檯 (DOUBLE)

C W48" x D24" x H30.5"

D W54" x D30" x H30.5"

E W60" x D30" x H30.5"

Dimension WxDxH (In)

TN L-SHAPED OFFICE DESK

鋼檯系列

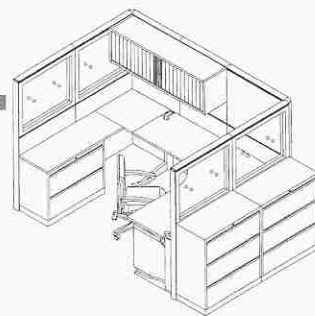

Our Best Seller: L-Shaped Office Desk....

- L-shaped desks are best choices for most commercial institutions
- Work surface is made of melamine faced chipboard (MFC) 18/25mm thick
- Full width cable tray which could be positioned at either side of the modesty panel to suit different needs
- Ship knocked-down to minimize freight cost

| MODEL NO. | Dimension |
|-----------|-------------------|
| TN-157 | W1500xD700XH750mm |
| TN-167 | W1600xD700XH750mm |
| TN-187 | W1800xD700XH750mm |
| TNH-90 | W900xD550XH750mm |
| TNH-100 | W1000xD550XH750mm |
| TN-M3 | W410xD529XH650mm |



| MODEL NO. | Dimension |
|-----------|-------------------------------|
| TNL-167 | W1600xWD700xL1600xD600xH750mm |
| TNL-157 | W1500xWD600xL1500xD600xH750mm |



F4 Folder



TN-M3



KD85CB伸縮型桌面鍵盤座

- 結構堅固，可承托21"顯示屏及負重達80磅
- 附設3M™凝膠碗墊及3M™穿棧光學滑鼠墊面
- 簡易設計，無需安裝
- 27.5" x 18.8" x 4.1"



KD45伸縮型桌底鍵盤座

- 輕便式設計，安裝簡易
- 提供桌下三種高度調校
- 附設3M™凝膠碗墊及3M™穿棧光學滑鼠墊面
- 23.2" x 16.1" x 2.3"



星型旋鈕調校托盤高低及傾斜度

AKT60LE / AKT65LE

- 一體化托盤兼容鍵盤與滑鼠
- 單臂式設計，適合安裝於狹小的工作空間
- 附設3M™凝膠碗墊及3M™穿棧光學滑鼠墊面
- 滑鼠墊面可置於托盤的左邊或右邊
- 高度調校範圍：桌上1-1/2"至桌下3-1/2"
- 傾斜角度：+15°/-15°
- 25" x 11" x 1.5"



- FR430CB: 18"x13"x4"
- FR530CB: 22"x14"x4"



FR430CB / FR530CB適體腳踏

- 有效減低腿、背及頸部疲勞並改善腿部血液循環
- 備有4"-5"的高度調校，並可隨時以腳部調校傾斜度
- 特廣闊的踏板及鋼材構造提供可靠而穩定的承托
- 3M™ Safety-Walk™防滑墊面，防止腳部下滑

STEEL LOCKER

儲物櫃



L01

LB2

LB4

L3

L5

L6

LP-9



LQ803



LQ806

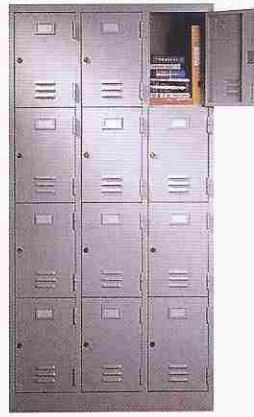

LQ812



LQ1+D

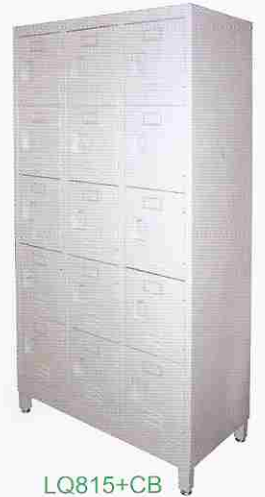

LQ815+CB

06

Accessories 配套

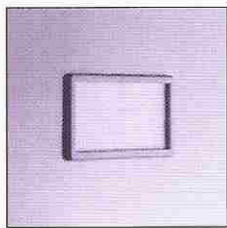

Index
目錄座

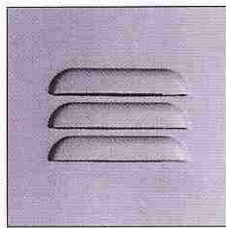

Ventilation Slot
通風槽



Clothing Rod
掛衣通

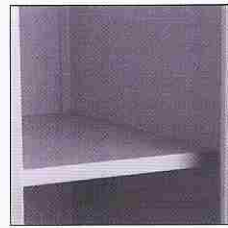

Shelf
層板



Caster
轆 3" 4" 5"

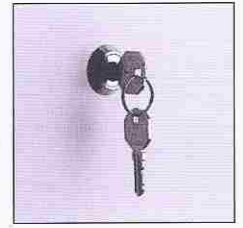

Lock set (1)
標準鎖



Lock set (2)
鎖牌

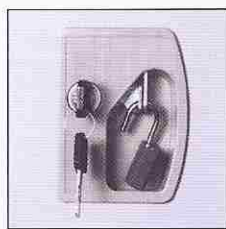

Lock set (3)
凹抽明掛鎖

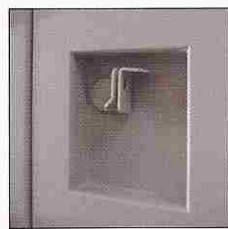

Lock set (4)
凹抽扣鎖



Lock set (5)
閃電鎖

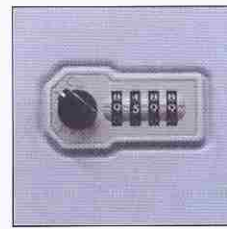

Lock set (6)
撥字密碼鎖



Lock set (7)
電子密碼鎖

STEEL LOCKER

儲物櫃



L01 單門

W12.25" x D21" x H70"
(櫃門: W10.25" x H65")



LB2 兩門

W12.25" x D21" x H70"
(櫃門: W10.25" x H32")



L02 雙門

W23.5" x D21" x H70"
(櫃門: W10.25" x H65")



LQ803 三門

W35" x D21" x H70"
(櫃門: W10.25" x H65")



LB4 四門

W23.5" x D21" x H70"
(櫃門: W10.25" x H32")

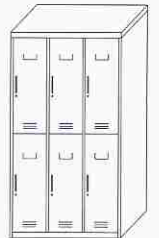

LQ806 六門

W35" x D21" x H70"
(櫃門: W10.25" x H32")

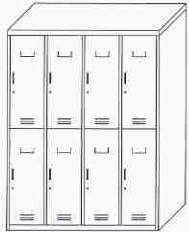

L08 八門

W46.5" x D21" x H70"
(櫃門: W10.25" x H32")

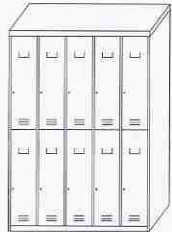

LB10 十門

W43.5" x D21" x H70"
(櫃門: W7.5" x H32")



L1 一門

W12.25" x D18" x H15"
(櫃門: W10.25" x H13")



L3 三門

W12.25" x D18" x H70"
(櫃門: W10.25" x H21")



L5 五門

W12.25" x D18" x H70"
(櫃門: W10.25" x H13")

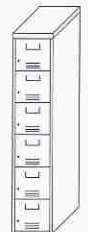

L6 大門

W12.25" x D18" x H70"
(櫃門: W10.25" x H10")

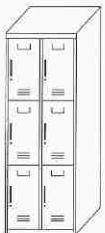

L06 六門

W23.5" x D18" x H70"
(櫃門: W10.25" x H21")



LB6 六門

W35" x D18" x H48"
(櫃門: W10.25" x H21")

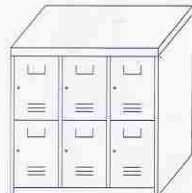

LQ6 六門

W35" x D18" x H37"
(櫃門: W10.25" x H16")



L8 八門

W23.5" x D18" x H70"
(櫃門: W10.25" x H16")



L9 九門

W35" x D18" x H70"
(櫃門: W10.25" x H21")

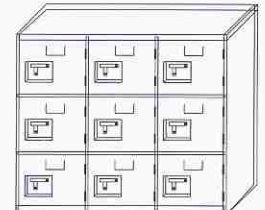

LP9 九門

W51.5" x D13" x H43"
(櫃門: W15.75" x H13")



L10 十門

W23.5" x D18" x H70"
(櫃門: W10.25" x H13")



L12 十二門

W23.5" x D18" x H70"
(櫃門: W10.25" x H10")



LQ812 十二門

W35" x D18" x H70"
(櫃門: W10.25" x H16")



LQ815 十五門

W35" x D18" x H70"
(櫃門: W10.25" x H13")

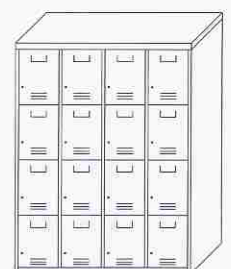

L16 十六門

W46.5" x D18" x H70"
(櫃門: W10.25" x H16")



L18 十八門

W35" x D18" x H70"
(櫃門: W10.25" x H10")

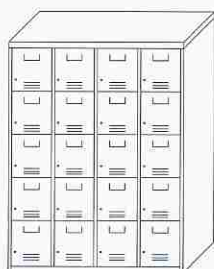

L20 二十門

W46.5" x D18" x H70"
(櫃門: W10.25" x H13")



L24 二十四門

W46.5" x D18" x H70"
(櫃門: W10.25" x H10")

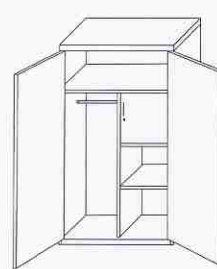

LQ1+D 掩門衣櫃

W35" x D18" x H70"

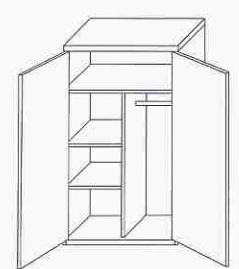

LQ1 掩門衣櫃

W35" x D18" x H70"

Professional & Living Workbenches

AFT 名稱：AFT 美式摺檯 Folding Table
規格：圓角木板面, U 字型摺合腳架



| 摺檯型號 | 檯面尺寸 |
|----------|------------------|
| MODEL | W. D. H |
| AFT-1545 | 1500 x 450 x 740 |
| AFT-1560 | 1500 x 600 x 740 |
| AFT-1575 | 1500 x 750 x 740 |
| AFT-1590 | 1500 x 900 x 740 |
| AFT-1845 | 1800 x 450 x 740 |
| AFT-1860 | 1800 x 600 x 740 |
| AFT-1875 | 1800 x 750 x 740 |
| AFT-1890 | 1800 x 900 x 740 |

TNS 名稱：TNS 日式摺檯 Folding Table
規格：方角木板面, H 字型摺合腳架



| 摺檯型號 | 檯面尺寸 |
|----------|------------------|
| MODEL | W. D. H |
| TNS-1545 | 1500 x 450 x 740 |
| TNS-1560 | 1500 x 600 x 740 |
| TNS-1575 | 1500 x 750 x 740 |
| TNS-1845 | 1800 x 450 x 740 |
| TNS-1860 | 1800 x 600 x 740 |
| TNS-1875 | 1800 x 750 x 740 |

LFT 名稱：LFT 前檔板摺檯 Folding Table W / Front panel
規格：方角木板面, T 字型前翻活動架 (黑架)



| 摺檯型號 | 檯面尺寸 |
|----------|------------------|
| MODEL | W. D. H |
| LFT-1545 | 1500 x 450 x 750 |
| LFT-1560 | 1500 x 600 x 750 |
| LFT-1645 | 1600 x 450 x 750 |
| LFT-1660 | 1600 x 600 x 750 |
| LFT-1845 | 1800 x 450 x 750 |
| LFT-1860 | 1800 x 600 x 750 |

TKT 名稱：TKT 日式摺檯 Folding Table
規格：方角木板面, 有底架, H 字型摺合腳架



| 摺檯型號 | 檯面尺寸 |
|----------|------------------|
| MODEL | W. D. H |
| TKT-1545 | 1500 x 450 x 740 |
| TKT-1560 | 1500 x 600 x 740 |
| TKT-1575 | 1500 x 750 x 740 |
| TKT-1845 | 1800 x 450 x 740 |
| TKT-1860 | 1800 x 600 x 740 |
| TKT-1875 | 1800 x 750 x 740 |

08



| 檯板型號 | 檯面尺寸 |
|---------|-----------------|
| MODEL | W. H. T |
| LFP-154 | 1500 x 400 x 16 |
| LFP-164 | 1600 x 400 x 16 |
| LFP-184 | 1800 x 400 x 16 |

NC Folding Table 多效能摺檯

- NC460-1 \varnothing 1220x750
- NC460-2 \varnothing 1520x750
- NC460-3 \varnothing 1830x750



- NC461-1 760 x 760 x 750
- NC461-2 915 x 915 x 750



- NC463-1 1520 x 760 x 750
- NC463-2 1830 x 915 x 750

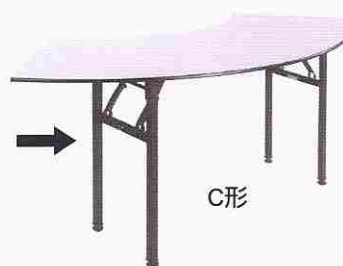

TW 名稱：TW 會議檯 Working Table
規格：方角木板面, 日字型方通架



| 檯型號 | 檯面尺寸 | 檯型號 | 檯面尺寸 |
|---------|------------------|---------|-------------------|
| MODEL | W. D. H | MODEL | W. D. H |
| TW-1260 | 1200 x 600 x 774 | TW-1812 | 1800 x 1200 x 774 |
| TW-1560 | 1500 x 600 x 774 | TW-2160 | 2100 x 600 x 774 |
| TW-1575 | 1500 x 750 x 774 | TW-2175 | 2100 x 750 x 774 |
| TW-1860 | 1800 x 600 x 774 | TW-2190 | 2100 x 900 x 774 |
| TW-1875 | 1800 x 750 x 774 | TW-1212 | 1200 x 1200 x 774 |
| TW-1890 | 1800 x 900 x 774 | TW-1512 | 1500 x 1200 x 774 |

檯面顏色



檯架顏色



Dimension WxDxH (mm)

MOVING TABLE



U-98-TC



U-989F



READING TABLE

Z-6 六人桌

W2000 x D1000 x H750

Z-4 四人桌

W1500 x D1000 x H750



SD-157

WORKBENCH 操作檯

W1500 x D700 x H800

CHOICES ON TABLE RACK • 多樣式架款選擇



STORAGE RACK • 貨倉儲物架

HCL SERIES MEDIUM STORAGE RACK

HCL 鋼制中型貨倉儲物架

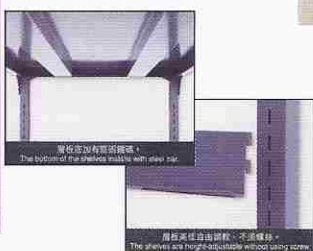

貨架鋼材用進口優質國際標準鍍鋅片加工成型，表面經防銹處理，靜電粉劑噴塗。裝拆簡易，可接駁多樣式層格設計，負重力強。

HCL貨倉架配套及層板均為鋼制，調較高度方位以50mm為間距，可自由操控。

10

| 層板尺寸 Shelf Dimension W x DH (mm) | 立柱高度 Column Height (mm) | 承重能力 Load capacity Kg/Shelf |
|--|-------------------------------|-----------------------------------|
| 900x450 | 1500 1800 2100 2400 | 250 |
| 900x600 | | 300 |
| 900x750 | | 300 |
| 900x900 | | 300 |
| 1200x450 | | 250 |
| 1200x600 | | 300 |
| 1200x750 | | 300 |
| 1200x900 | | 300 |
| 1500x450 | | 250 |
| 1500x600 | | 300 |
| 1500x750 | | 300 |
| 1500x900 | | 330 |
| 1800x450 | | 250 |
| 1800x600 | | 300 |
| 1800x750 | | 300 |
| 1800x900 | | 330 |

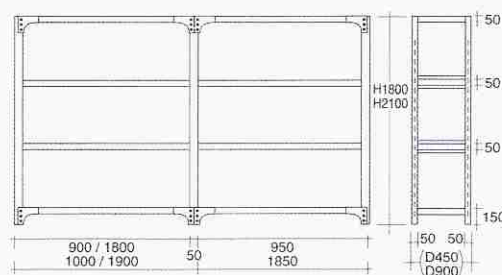

HGX SERIES HEAVY STORAGE RACK

HGX 鋼制重型貨倉儲物架

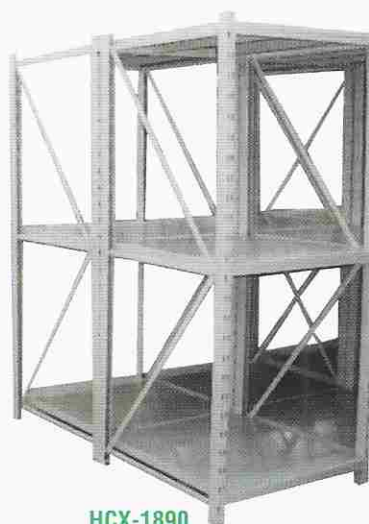

訂購數量最少10套

HGX-1890

SIZE:W1800 x D900 x H2100

Dimension WxDxH (mm)

STEEL FILING CABINET • 文件鋼櫃

Lateral Filing Cabinet

橫式檔案文件鋼櫃
F4 SIZE FOLDER



- Q820-2**
兩抽櫃 Two Drawers
尺寸 Size: W900 x D450 x H724 mm
- Q820-3**
三抽櫃 Three Drawers
尺寸 Size: W900 x D450 x H1028 mm
- Q820-4**
四抽櫃 Four Drawers
尺寸 Size: W900 x D450 x H1335 mm
- Q820-T**
櫃頂板 Cabinet Wooden Top
尺寸 Size: W900 x D450 x T25 mm

Steel Fire-proof Filing Cabinet

防火保險文件鋼櫃
F4 SIZE FOLDER

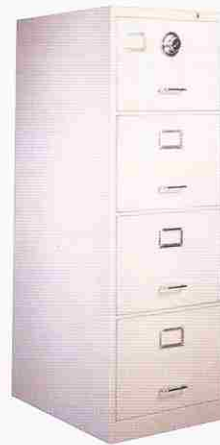

- KF609-2**
兩抽櫃 Two Drawers
尺寸 Size: W21" x D28" x H32"
- KF609-3**
三抽櫃 Three Drawers
尺寸 Size: W21" x D28" x H46"
- KF609-4**
四抽櫃 Four Drawers
尺寸 Size: W21" x D28" x H60"

Vertical Filing Cabinet

直式檔案文件鋼櫃
F4 SIZE FOLDER

- Q902-2**
兩抽櫃 Two Drawers
尺寸 Size: W18" x D25" x H28"
- Q902-3**
三抽櫃 Three Drawers
尺寸 Size: W18" x D25" x H40"
- Q902-4**
四抽櫃 Four Drawers
尺寸 Size: W18" x D25" x H52"
- Q902-T**
櫃頂板 Cabinet Wooden Top
尺寸 Size: W18" x D25" x T1"



Steel Safe Filing Cabinet

保險文件鋼櫃
F4 SIZE FOLDER

- K609-2**
兩抽櫃 Two Drawers
尺寸 Size: W18" x D25" x H28"
- K609-3**
三抽櫃 Three Drawers
尺寸 Size: W18" x D25" x H40"
- K609-4**
四抽櫃 Four Drawers
尺寸 Size: W18" x D25" x H52"



Vertical Filing Cabinet

直式檔案文件鋼櫃
F4 SIZE FOLDER















- Q900-2**
兩抽櫃 Two Drawers
尺寸 Size: W18" x D25" x H28"
- Q900-3**
三抽櫃 Three Drawers
尺寸 Size: W18" x D25" x H40"
- Q900-4**
四抽櫃 Four Drawers
尺寸 Size: W18" x D25" x H52"
- Q900-T**
櫃頂板 Cabinet Wooden Top
尺寸 Size: W18" x D25" x T1"

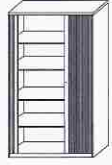
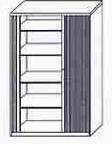
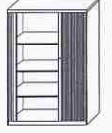

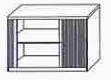
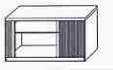
ROLLER SHUTTER DOOR CABINET • 膠閘捲門鋼櫃

CABINET TYPE (ACCESSORIES HAVE TO BE ORDERED SEPARATELY) All depth are 460mm 

捲門櫃類別 (配件須自行另配) 所有深度均為 460mm

| Height 高度 (mm) | 2100 | 1980 | 1800 | 1320 | 900 | 750 |
|--------------------|---|--|---|--|--|---|
| |  |  |  |  |  |  |
| Width 闊度 (1000 mm) | CH-82 | CH-78 | CH-71 | CH-52 | CH-35 | CH-29 |
| |  |  |  |  |  |  |
| Width 闊度 (1200 mm) | CH-82A | CH-78A | CH-71A | CH-52A | CH-35A | CH-29A |
| ACCESSORIES 配件系列 | Adjustable Shelf 層板  | Pull-Out Desk Top 拉板  | Pull-Out Frame 拉架  | Pull-Out Drawer 拉斗  | Wooden Top 櫃頂板  | Divider (H200mm) 分格板  |
| Width 闊度 (1000 mm) | CH-S10 | CH-T10 | CH-F10 | CH-D10 | CH-W10 | CH-810 |
| Width 闊度 (1200 mm) | CH-S12 | CH-T12 | CH-F12 | CH-D12 | CH-W12 | CH-812 |



Dimension WxDxH (mm)

Product Range



12

Open Unit

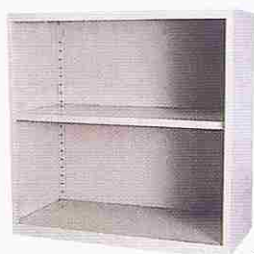

Q701
Open Two Shelf Cabinet
二層空格鋼櫃
Size: W35" x D16" x H35"



Q701 /3
Open Three Shelf Cabinet
三層空格鋼櫃
Size: W35" x D16" x H52"



Q700
Open Four Shelf Cabinet
四層空格鋼櫃
Size: W35" x D18" x H70"

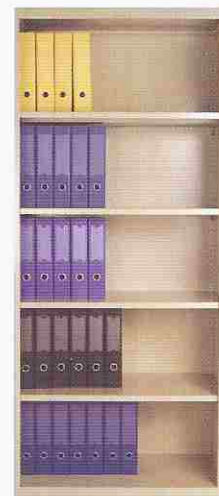

Q700 /5
Open Five Shelf Cabinet
五層空格鋼櫃
Size: W35" x D18" x H82.5"



Q705
Open 5-Tiers Book Rack
五層空格書架
Size: W32" x D12" x H60"

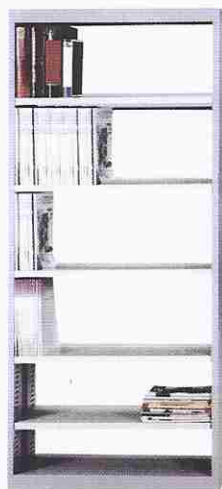

Q706
Open 6-Tiers Book Rack
六層空格書架
Size: W32" x D12" x H72"



Q707
Multi-purpose Shelf Cabinet
多層拉板空格鋼櫃
Size: W39" x D19" x H71"

Dimension WxDxH (In)

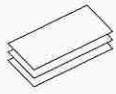

Panel
活動層板



Keylock
櫃門鎖



Handle Lock
閃電鎖



Handle Lock
電子鎖



Handle
標準膠凹抽

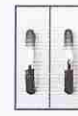

Handle
金屬拉抽



Handle
捉手抽

Opus - Filing & Storage



Q801
Sliding door Cabinet 移門鋼櫃
Size: W35" x D16" x H35"

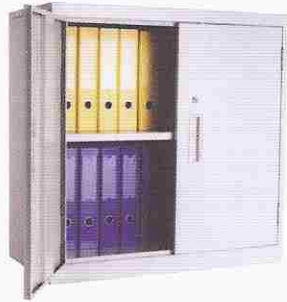

Q801A
Swing door Cabinet 掩門鋼櫃
Size: W35" x D16" x H35"



Q801B
Sliding door Cabinet 長移門鋼櫃
Size: W59" x D16" x H35"

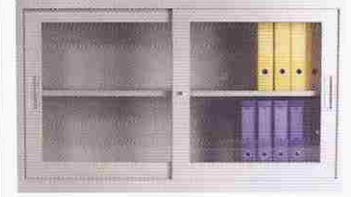

Q801B/GF
Steel Framed Sliding Glass door Cabinet
玻璃框移門鋼櫃
Size: W59" x D16" x H35"



Q801/GF
Steel Framed Sliding Glass door Cabinet
玻璃框移門鋼櫃
Size: W35" x D16" x H35"



Q801/WGF
Steel Framed Swing Glass door Cabinet
玻璃框掩門鋼櫃
Size: W35" x D16" x H35"



GS801
Glass door Cabinet 玻璃移門鋼櫃
Size: W35" x D16" x H35"



Q703
Open & Sliding door Cabinet
拼櫃鋼櫃
Size: W35" x D16" x H30"



Q801/3
Sliding door Cabinet 移門鋼櫃
Size: W35" x D16" x H52"

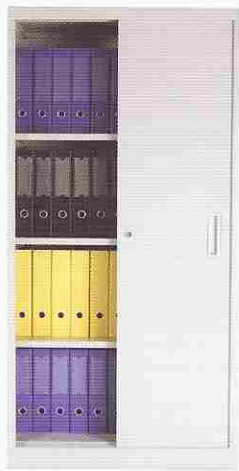

Q802
Sliding door Cabinet 高身移門鋼櫃
Size: W35" x D18" x H70"

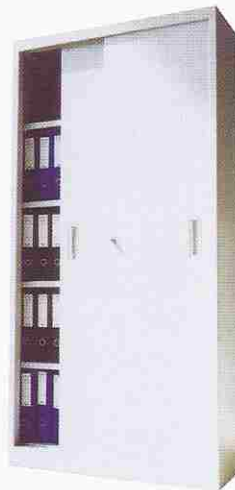

Q802/5
Sliding door Cabinet 高身移門鋼櫃
Size: W35" x D18" x H82.5"



Q802/SGF
Steel Framed Sliding Glass door Cabinet
高身玻璃框移門鋼櫃
Size: W35" x D18" x H70"



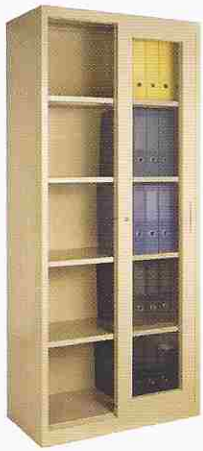

Q802/5SGF
Steel Framed Sliding Glass door Cabinet
高身玻璃框移門鋼櫃
Size: W35" x D18" x H82.5"



Q802A
Swing door Cabinet 高身掩門鋼櫃
Size: W35" x D18" x H70"



Q802A
Swing door Cabinet 高身掩門鋼櫃
Size: W35" x D18" x H70"

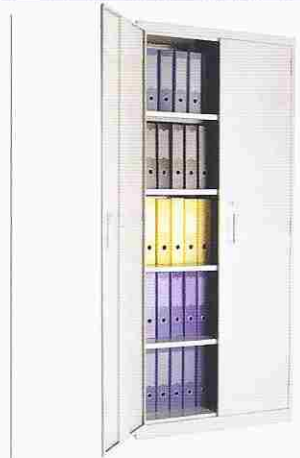

Q802A/5
Swing door Cabinet 高身掩門鋼櫃
Size: W35" x D18" x H82.5"



Q803/S
Upper Steel Framed Glass door & Lower Sliding door Cabinet 高上玻璃框下移門鋼櫃
Size: W35" x D18" x H70"



Q803/W
Upper Steel Framed Glass door & Lower Swing door Cabinet 高上玻璃框下掩門鋼櫃
Size: W35" x D18" x H70"



Q803/5R
Upper Steel Framed Glass door & Lower Shutter roller door Cabinet 高上玻璃框下捲門鋼櫃
Size: W35" x D18" x H82.5"

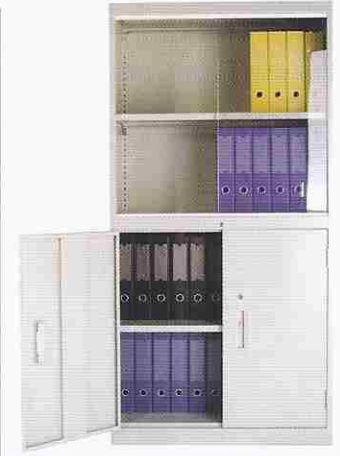

Q804/W
Upper Steel Glass door & Lower Swing door Cabinet 高上玻璃下掩門鋼櫃
Size: W35" x D18" x H70"

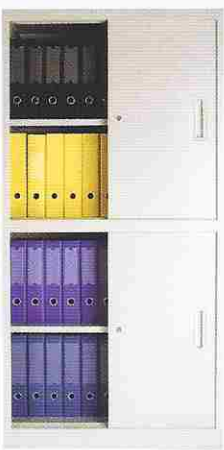

Q805
Upper & Lower Sliding door Cabinet 高上下移門鋼櫃
Size: W35" x D18" x H70"



Q805/W
Upper & Lower Swing door Cabinet 高上下掩門鋼櫃
Size: W35" x D18" x H70"



GS805
Upper & Lower Sliding Glass door Cabinet 高上下玻璃移門鋼櫃
Size: W35" x D18" x H70"



Q810
Double door Cabinet with Two Drawers 中二斗掩門文件鋼櫃
Size: W35" x D18" x H70"

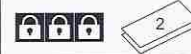

OFFICE AREA EQUIPMENT • 商務鋼具

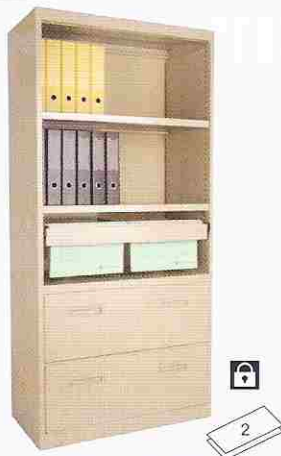

K607
Equipment filing Cabinet
多用途文件鋼櫃
Size: W36" x D18" x H76"



Q608A
4-Tiers with Swing door Magazine Cabinet
四格斜板雜誌鋼櫃
Size: W35" x D12" x H70"



Q608B
5-Tiers Magazine Cabinet
五格摺門雜誌鋼櫃
Size: W35" x D18" x H70"



L12D
12 Door Locker
12 門集件櫃
Size: W915 x D460 x H1958mm



K601
Fluorescent Lamp Table with 2 Drawers
二斗燈箱櫃
Size A : W42" x D36" x H36" (A1 圖紙)
Size B : W48" x D36" x H36" (A1 圖紙)
Size C : W54" x D36" x H36" (A0 圖紙)



K603
Fluorescent Lamp Table with 7 Drawers
七斗燈箱櫃
Size A : W42" x D36" x H36" (A1 圖紙)
Size B : W48" x D36" x H36" (A1 圖紙)
Size C : W54" x D36" x H36" (A0 圖紙)



K605
Four Drawers Plan Chest
四斗圖則櫃
Size A : W48" x D36" x H20.5" (A1 圖紙)
Size B : W51" x D37" x H20.5" (A0 圖紙)
Size C : W54" x D42" x H20.5" (A0 圖紙)



Q903
Tool Storage Cabinet
重物工具箱
四桶櫃 : W18" x D25" x H28"
六桶櫃 : W18" x D25" x H40"
八桶櫃 : W18" x D25" x H52"

15



QSD-6
6-Drawers Cabinet
六斗鋼櫃
Size: W18" x D20" x H28.5"

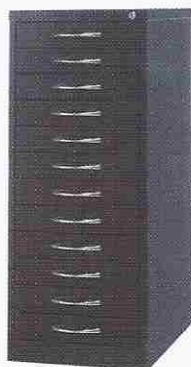

QSD-12
12-Drawers Cabinet
十二斗鋼櫃
Size: W18" x D20" x H52.5"



MAP RACK 圖架
A1 size map clips
附圖夾
A1-6 : W330 x D640 x H1026mm
A1-10 : W490 x D640 x H1026mm
A1-15 : W690 x D640 x H1026mm



MAP RACK 圖架
A0 size map clips
附圖夾
A0-6 : W330 x D820 x H1372mm
A0-10 : W490 x D820 x H1372mm
A0-15 : W690 x D820 x H1372mm
A0-24 : W1050 x D820 x H1372mm

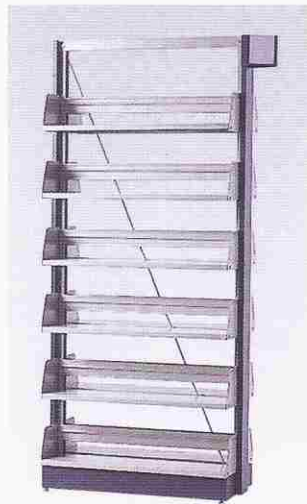
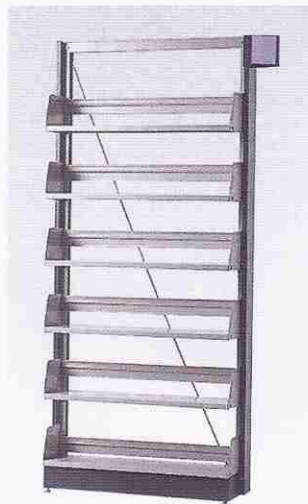
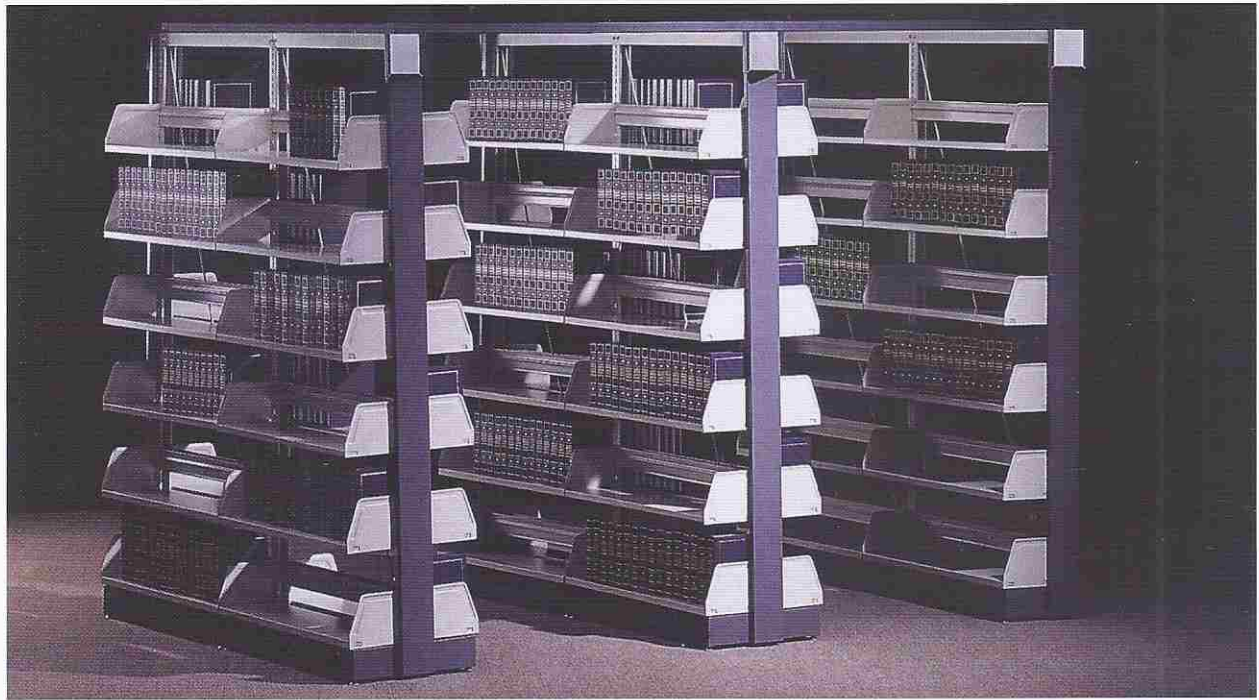

LR-0903SM-BE

Single Faced Library Rack
單面書架

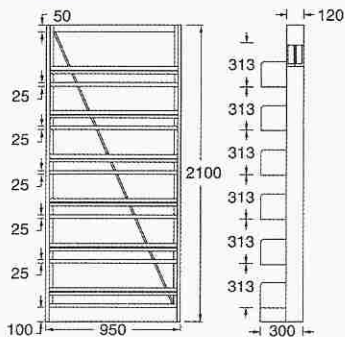

LR-0903SM-□□

6 Tiers Main Unit
六層基本架
W950 x D300 x H2100mm

LR-0903SE-□□

6 Tiers Extension Unit
六層增連架
W900 x D300 x H2100mm

LR-0904DM-BE

Double Faced Library Rack
雙面書架

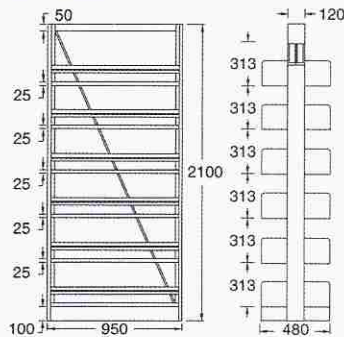

LR-0904DM-□□

6 Tiers Main Unit
六層基本架
W950 x D480 x H2100mm

LR-0904DE-□□

6 Tiers Extension Unit
六層增連架
W900 x D480 x H2100mm



Index Holder
目錄座



Side Panel
側擋板



Safety Bar
安全桿



Reinforced Beam
加強桿



Back Panel
背擋板

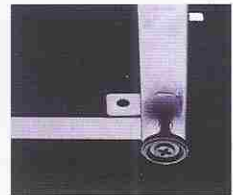

Adjuster
水平調較裝置

Color

顏色：

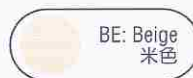

BE: Beige
米色

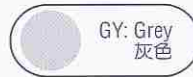

GY: Grey
灰色

Accessories
配件



LRA-09RS-□□
Adjustable Shelf
(Single / Double Faced
Rack Use)
活動層板(單/雙面書架用)
W900 x D215 x H25mm

CHIC SPACE CABINET AND O³ ODOR SMELL REDUCED SHOES CABINET SERIES



S door panel

387mm Height

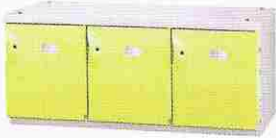

SC-303M
W890 x D350 x 387 mm

M door panel

550mm Height



SCM3-3M3S
W890 x D350 x 550 mm



714mm Height



SCM3-2M8S
W890 x D350 x H714 mm



SC-306M
W890 x D350 x H714 mm

880mm Height



SCM3-2M11S
W890 x D350 x H880 mm



SCM3-6M3S
W890 x D350 x H880 mm

1040mm Height

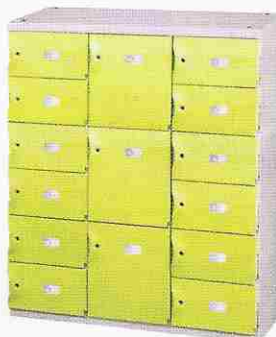

SCM3-3M12S
W890 x D350 x H1040 mm

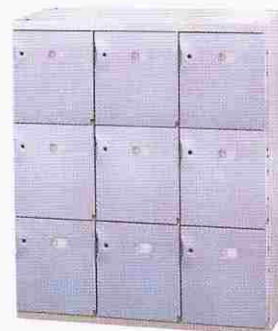

SC-309M
W890 x D350 x H1040 mm

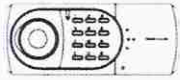

EN: 電子鎖連柄 (圓柄)
CS-001EN, F119EN,
F125EN, F4-125EN,
MC-530EN

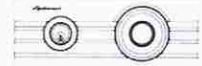
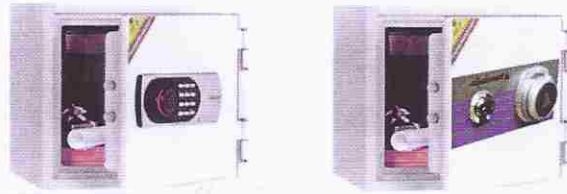

CK: 轉盤鎖連匙
CS-001CK, F119CK,
F125CK, F4-125CK,
MC-530CK

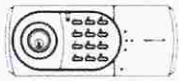

EK: 電子鎖連匙
CS-001EK, F119EK,
F125EK, F4-125EK,
MC-530EK

橫型夾萬 (A4紙橫放)

| Model (電子鎖) | Model (機械鎖) | Size (mm) | Weight (Kgs) | Tray |
|--------------|--------------|---|--------------|------|
| CS-001 EN/EK | CS-001 CK/KK | 410W x 382D x 300H (16.14" x 15" x 11.81") | 32 (71 lbs) | 0 |
| F-119 EN/EK | F-119 CK/KK | 412W x 407D x 352H (16.22" x 16" x 13.86") | 39 (86 lbs) | 1 |
| MC-420 EN/EK | MC-420 CK/KK | 515W x 483D x 404H (20.28" x 19" x 15.91") | 62 (137 lbs) | 1 |

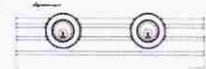

KK: 雙匙
CS-001KK, F119KK,
F125KK, F4-125KK,
MC-530KK

(轉盤鎖不能改密碼)

(電子鎖可自選密碼) 柄可改匙，並可加警鐘，A4紙可平放



直型夾萬 (A4紙直放)

| Model (電子鎖) | Model (機械鎖) | Outside Size (mm) | Inside Size (mm) | Weight (Kgs) | Tray | Shelf |
|--------------|--------------|---|---|--------------|------|-------|
| F-125 EN/EK | F-125 CK/KK | 352W x 473D x 415H (13.86" x 18.5" x 16.34") | 260W x 304D x 320H (10.2" x 12.0" x 12.6") | 45 (99 lbs) | 1 | 1 |
| F4-125 EN/EK | F4-125 CK/KK | 352W x 510D x 415H (13.86" x 20" x 16.34") | 260W x 343D x 320H (10.2" x 13.5" x 12.6") | 47 (103 lbs) | 1 | 1 |
| MC-530 EN/EK | MC-530 CK/KK | 404W x 483D x 515H (15.91" x 19" x 20.28") | 300W x 300D x 410H (11.8" x 11.8" x 16.2") | 62 (137 lbs) | 1 | 1 |

柄可改匙，並可加警鐘，A4紙可平放

以上防火夾萬之標準色為米色，橫型及直型夾萬全部可加警鐘。

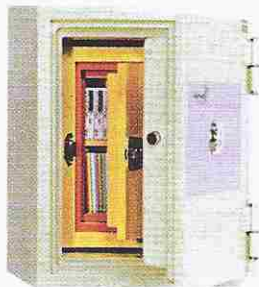

電腦磁碟防火箱

| Model | Outside Size (mm) | Inside Size (mm) | Weight (Kgs) |
|-------|---|--|--------------|
| 125D | 352W x 460D x 420H (13.86" x 18" x 16.53") | 156W x 165D x 216H (6.14" x 6.49" x 8.50") | 41 (90 lbs) |
| 530D | 404W x 460D x 522H (15.9" x 18" x 20.55") | 196W x 165D x 306H (7.71" x 6.49" x 12.04") | 62 (137 lbs) |



酒店式夾萬 (可加信封口)

| Model (電子鎖) | Size (mm) | Weight (Kgs) |
|-------------|---|--------------|
| P-25 EN/EK | 360W x 355D x 250H (14.17" x 14" x 9.84") | 13 (29 lbs) |
| P-30 EN/EK | 420W x 415D x 300H (16.53" x 16.5" x 11.81") | 17 (37 lbs) |

柄可改匙，A4紙可平放

(電子鎖可自選密碼)



EHK: 電子鎖連匙 (一字柄)

JH-60EHK, JH-70EHK,
JH-80EHK, MO-100EHK,
MO-120EHK



EH: 電子鎖連柄 (一字柄)

JH-60EH, JH-80EH

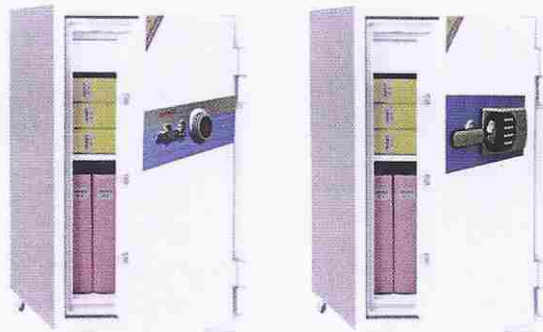

ISO 9001
CERTIFIED



國際品質認可證書



Fire Resistance tested and
Certified 350-1 hr by UL.
(Underwriter's Laboratories
Inc.)

美國防火證書



Sveriges Provnings-och
Forskningsinstitut AB
(Swedish National Testing
and Research Institute)
tested and approved in fire
resistance (NT FIRE 017,
Brandklass 60P. 90P)

瑞典防火證書



Fire tested and approved by
Korea Industrial Advancement
Administration,
Diplomat Safe obtained KS
certificate first in the field of ...
safes in Korea.

韓國防火證書

中型夾萬

| Model (電子鎖) | Model (轉盤鎖) | Outside Size (mm) | Inside Size (mm) | Weight (Kgs) | Drawer | Shelf |
|---------------|--------------|--|---|---------------|--------|-------|
| JH-060 EHK/EH | JH-060 CK/KK | 470W x 508D x 650H (18.50" x 20" x 25.59") | 350W x 300D x 480H (13.8" x 11.8" x 18.9") | 91 (201 lbs) | 1 | 1 |
| JH-070 EHK/EH | JH-070 CK/KK | 503W x 530D x 685H (19.8" x 21" x 26.97") | 380W x 330D x 515H (15.0" x 13.0" x 20.3") | 106 (234 lbs) | 1 | 1 |
| JH-080 EHK/EH | JH-080 CK | 520W x 550D x 875H (20.47" x 21.75" x 34.45") | 380W x 330D x 676H (15.0" x 13.0" x 26.6") | 147 (324 lbs) | 1 | 1 |

(轉盤鎖不能改密碼)



CK: 轉盤鎖連柄 (一字柄)

JH-60 CK, JH-70 CK,
JH-80 CK, MO-100 CK,
MO-120 CK



KK: 雙匙
60KK



大型夾萬

| Model (電子鎖) | Model (轉盤鎖) | Outside Size (mm) | Inside Size (mm) | Weight (Kgs) | Drawer | Shelf |
|-------------|-------------|---|---|---------------|--------|-------|
| MO-100 EHK | MO-100CK | 655W x 590D x 1020H (25.79" x 23.25" x 40.16") | 475W x 350D x 780H (18.7" x 13.8" x 30.7") | 231 (509 lbs) | 1 | 2 |
| MO-120 EHK | MO-120CK | 655W x 590D x 1220H (25.79" x 23.25" x 48.03") | 475W x 350D x 980H (18.7" x 13.8" x 38.6") | 272 (600 lbs) | 1 | 2 |

以上防火夾萬之標準色為米色

· 保用期一年 ·

通過嚴格測試，取得各國及格防火證書

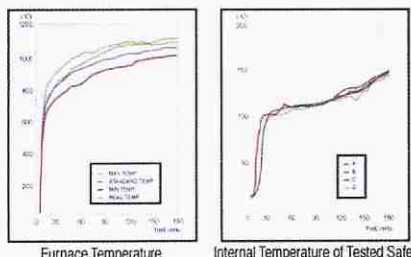

(測試3小時) 防火證書1-2小時

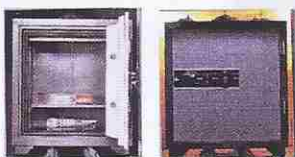

1

2

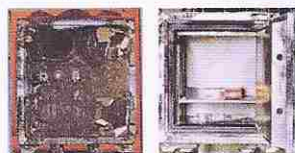

3

4

雙門大夾萬

| Model | Outside Size (mm) | Inside Size (mm) | Weight (Kgs) |
|-----------|---|--|---------------|
| S-300 EHK | 950W x 730D x 1215H (37.41" x 28.75" x 47.84") | 770W x 490D x 980H (30.32" x 19.29" x 38.59") | 360 (790 lbs) |